

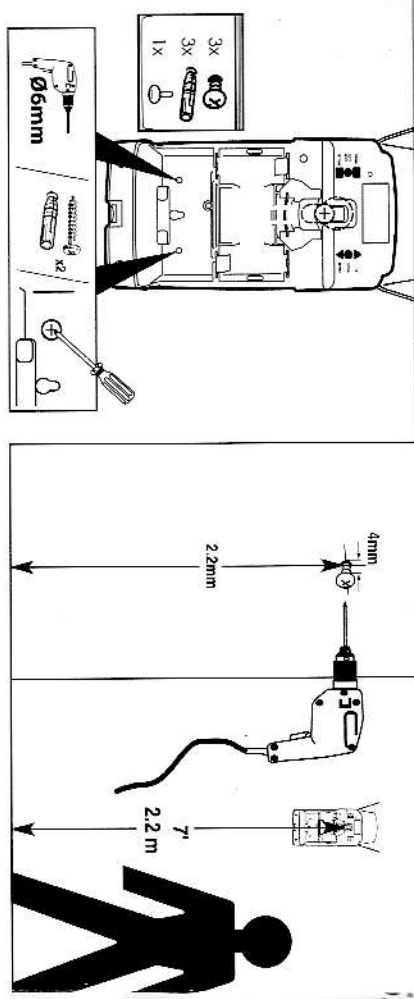

2. Fit dispenser to Wall

Fitting Instructions

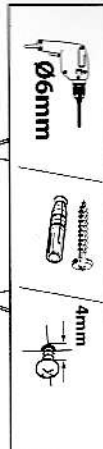

Not Suitable for carpeted areas

3. Load Batteries & Quick Start

Battery Instructions

Batteries not included (2 x C (LR14) 1.5V High Quality Alkaline batteries required)

Load Batteries and then set time.

1. Set hour, Use up and down buttons to adjust time. Press Enter When Correct

2. Set minutes. Use up and down buttons to adjust time. Press Enter when correct

3. Press Reset button for 3 sec. and close lid

4. Dispenser will spray 8 times to test system and is ready for use

If the time is not set after 30 mins, the dispenser will automatically reset to a default of 14:7 spray interval 14 mins & 24 secs (this is 24h, 7 day operating mode). If you want to customise the setting see step 5 before loading refill.

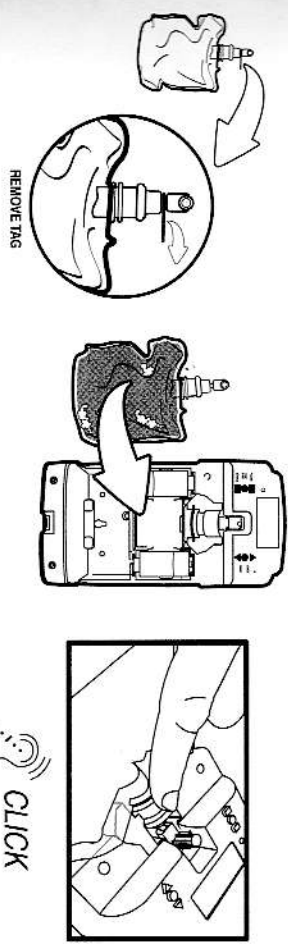
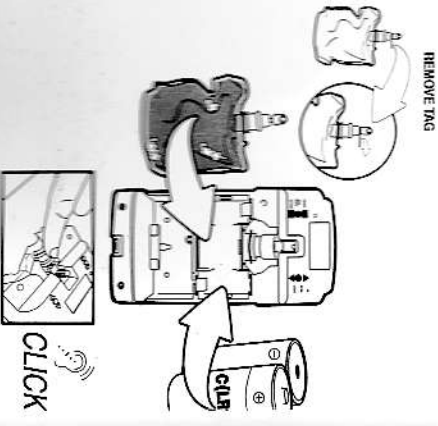

Customised Programming

Press SETTING button

Enter Step	Day of the week is blanking	Press UP/DOWN button	Press ENTER button	Day of the week options by turns Mo-Tu-We-Th-Fr-Sa-Su-Mo...
Enter Step 1	Starts from Monday	Select the correct day of the week	Confirm setting and steps to next mode setting	00
Enter Step 2	Hour of the week is blanking	Starts from 00	Confirm setting and steps to next mode setting	Hour options by turns: 00-01-02...-23-00...
Enter Step 3	Minute of the week is blanking	Starts from 00	Confirm setting and steps to next mode setting	Minute options by turns: 00-01-02...-59-00...
Enter Step 4	The x over the alarm is blanking	Press UP/DOWN button	Press ENTER button	<input checked="" type="checkbox"/> If x is visible, it means the alarm is off <input type="checkbox"/> If x is invisible, it means the alarm is on
Enter Step 5	To select days of operation	Working day is blanking	Confirm setting and steps to next mode setting	Working day options by turns: Mo-Fr Mo-Su (default is Mo-Su)
Enter Step 6	To select hours of operation	Working hours per day is blanking	Confirm setting and steps to next mode setting	Working hours options by turns: 24h 12h 16h 24h (default is 24h)
Enter Step 7	To select start hour	Start time is blanking	Confirm setting and steps to next mode setting	Start time options by turns: 00:01-02...-23:00... (default is 00)

TIME ON OFF

00:00

60d

Mo-Fr Mo-Sa Mo-Su

START

24h

12h

16h

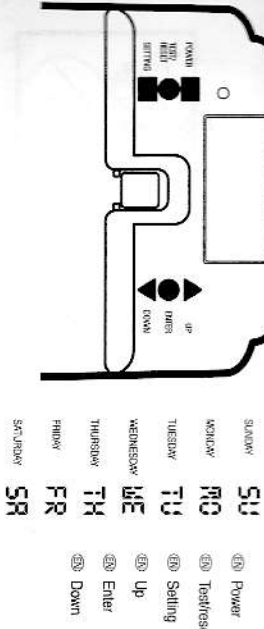

- 1 Power supply: 2pcs C size High Quality Alkaline Batteries (1.5V*2)
- 2 POWER button
- 3 Press POWER button to activate or shutdown the dispenser.
- 3 TEST button
 - To test system is working, press once.
 - To reset the dispenser after new refill is loaded, press for 3 seconds
 - The dispenser will then spray 8 litres in order to prime the refill.
- 4 SETTING button
 - To set program
 - UP-----increase
 - ENTER-----Confirm the operation
 - DOWN-----decrease

Alarm	after 5800 times	after 6000 times	Alarm Interval
<input type="checkbox"/>	beeping and keep spraying	beeping but not spraying	10 seconds
<input checked="" type="checkbox"/>	not beeping and keep spraying	not beeping and not spraying	

Setting	6000 times	
	Min	Sec
24H	Mo-Fr Mo-Sa Mo-Su	10 12 14
12H	Mo-Fr Mo-Sa Mo-Su	5 6 7
16H	Mo-Fr Mo-Sa Mo-Su	7 8 9

(i) Replacing Batteries

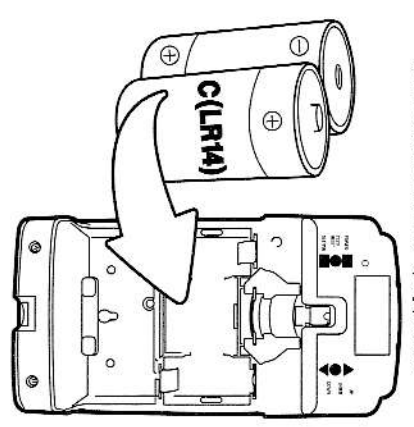
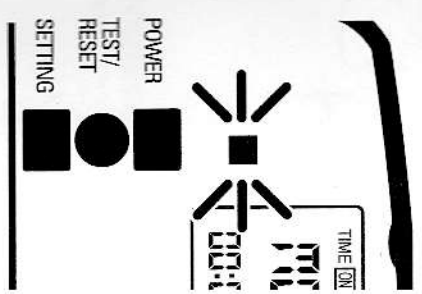

When red light flashes replace batteries within 15 seconds to ensure current settings remain otherwise dispenser will return to default with 24/7 spray pattern.

(ii) Replacing Refill Bag

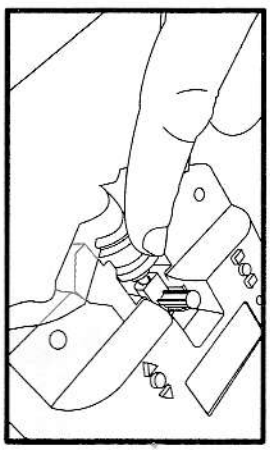
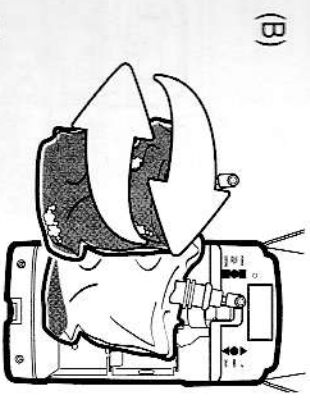
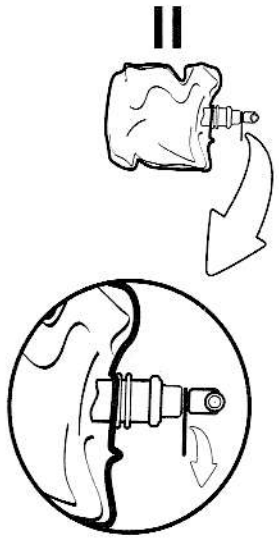
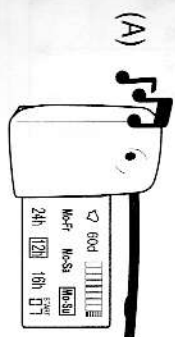

Hold for 3 seconds for reset.